

FM-5 RCA Jack Replacement ASSEMBLY MANUAL



© 2018-2020 Akitika, LLC
All rights reserved
Revision 1p09 October 30, 2020

Table of Contents

Table of Contents	2
Table of Figures	2
Section 1: About This Manual	3
Who Should Attempt these Projects?	3
Tools and Supplies You'll Need	3
Recommended Solder	3
Project Overview	3
Important Safety Notes	4
Section 2: Replacing the Original RCA Jacks	4
Preparation	4
Accessing the RCA Jacks	4
Building the new RCA Jack assemblies	5
If your FM-5 has PC-25 and PC-26 circuit boards	6
Moving the wires from the old to the new jacks (PC-25 and PC-26).....	7
Move the wires one at a time (PC-25 and PC-26)	7
If your FM-5 has PC-20 and PC-21 circuit boards	8
Moving the wires from the old to the new jacks (PC-20 and PC-21).....	9
Install the New Jacks and Reassemble the Tuner	9

Table of Figures

Figure 1-Remove 4 screws, two as shown above, and two on the opposite side of the chassis	5
Figure 2-Installing the Jacks and ground lugs	5
Figure 3-Pre-wire the jacks as shown, but don't yet solder the three indicated places	6
Figure 4-Set the new and old jacks side-by-side	7
Figure 5-ground straps for PC-20 and PC-21 version of FM-5	8
Figure 6-Set the new and old jacks side-by-side (PC-20 and PC-21 version).....	9
Figure 7-New jacks installed	10

Section 1: About This Manual

This manual gives the information you need to build and install replacement RCA jacks into the Dynaco FM-5 tuner. Over the course of many years, the original jacks can become oxidized and corroded, which leads to poor conductivity. That lack of conductivity can lead to unreliable and/or high resistance connections that can cause hum, noise, and distortion.

Who Should Attempt these Projects?

You can build this kit if you can:

1. solder (using normal rosin core solder and a soldering iron),
2. use simple hand tools like screwdrivers, wire cutters, and pliers, and
3. Read and follow directions.

It helps if you:

1. know a bit about electronics, or
2. have a friend who knows a bit about electronics
3. can get to YouTube to watch a few helpful videos about the assembly process (not available as of this version of the manual)

Tools and Supplies You'll Need

You'll need the following tools:

1. flat blade screwdrivers for #4 and #6 screws, #2 Philips head screwdriver
2. needle nose pliers (helpful, but not strictly necessary)
3. plier to hold the RCA jacks, a nut driver to tighten the RCA jack mounting nuts
4. pencil type soldering iron of 25 to 50 Watts (no huge honking soldering guns or blowtorches)
5. wire cutters and strippers
6. Magnifying glass, if you're over 42!

Recommended Solder

The kit must be assembled with 60/40 Rosin Core solder. The recommended diameter is 0.032 inches. Among many such sources of solder, I have used

- Kester 24-6337-8800 50 Activated Rosin Cored Wire Solder Roll, 245 No-Clean, 63/37 Alloy, 0.031" Diameter. This is a 1 pound roll of solder. No-clean means that it leaves the minimum possible residue on the PCB.
- MG Chemicals 60/40 Rosin Core Leaded Solder, 0.032" Diameter, 0.6 oz Pocket Pack
- Radio Shack solder, although it's hard to find given Radio Shack's bankruptcy. Still if you have some, and it's about 0.32" in diameter, it's fine to use.

Project Overview

Broadly, the project consists of the following steps:

1. Unplug the tuner and remove the cover.
2. Remove the 4 screws that hold the back panel in place.

3. Remove the original RCA jacks.
4. Build the new RCA jack assemblies and install them.
5. Fasten the back panel in place and re-install the cover.

Important Safety Notes

By purchasing, using, or assembling this kit, you have agreed to hold AkitikA, LLC harmless for any injuries you may receive in its assembly and/or use. To prevent injuries:

- Wear safety glasses when soldering to prevent eye injuries.
- Always unplug the power before working on the equipment.
- Large capacitors hold lots of energy for a long time. Before you put your hands into the equipment:
 - Pull the AC plug!
 - Wait 1 full minute for the capacitors to discharge!
- Remove jewelry and rings from your hands and wrists, or anything that might dangle into the amplifier.
- If working in the amplifier, keep one hand in your pocket, especially if you're near the power supply or power supply wires. This can prevent serious shocks.
- Build with a buddy nearby. If you've ignored all the previous advice, they can dial 911 or get you to the hospital.

Section 2: Replacing the Original RCA Jacks

Preparation

- Set up a clear space in which to work.
- Get a soup bowl and a towel. The soup bowl holds the parts as you disassemble the tuner. The towel will be used to protect the chassis of your tuner from scratches.
- **Remove the power plug from the AC wall socket!**

Accessing the RCA Jacks

1. Remove the four screws, two on each side of the cover, that hold the cover in place. Put the screws into your soup bowl for safe keeping. Please note that some FM-5's have a 5th screw in the top strip of the cover where it meets the back panel.
2. Lift off the cover and set it aside.
3. Remove the four screws (flat-bladed screwdriver or a 1/4" nut-driver) that hold the back panel to the bottom of the chassis. Figure 1 shows the location of two of the screws. The other two screws are located on the opposite side of the chassis.

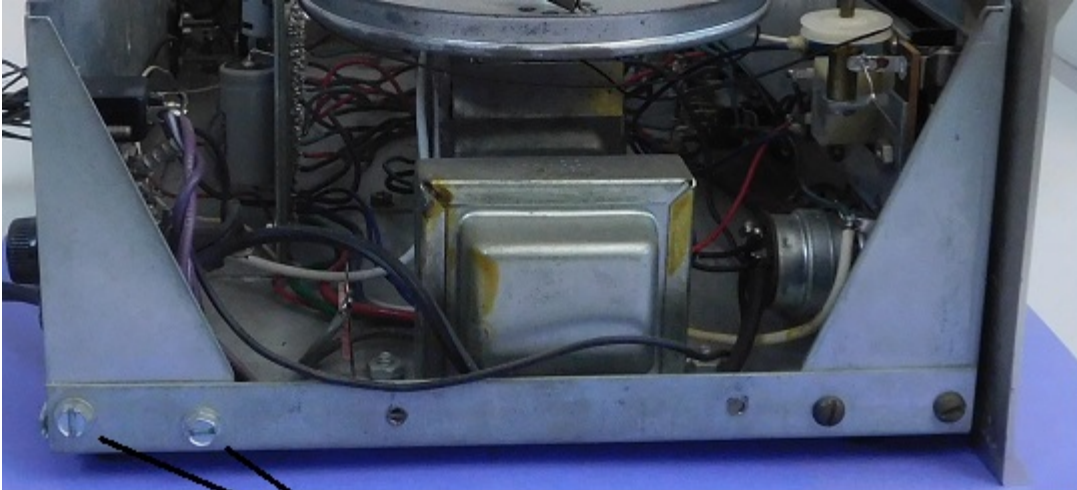

remove these screws

Figure 1-Remove 4 screws, two as shown above, and two on the opposite side of the chassis

Building the new RCA Jack assemblies

You will build two jack assemblies:

- The LEFT channel jack assembly using white insulator RCA jacks
- The RIGHT channel jack assembly using red insulator RCA jacks

Use Figure 2 as your guide to the installation of ground lugs. Note the following:

- Only two of three ground lugs are installed
- Note the orientation of the PCBs and jacks and the solder cups of the center leads
- Note the orientation of the ground lugs:
 - Down for the white insulator RCA jacks
 - Up for the red insulator RCA jacks

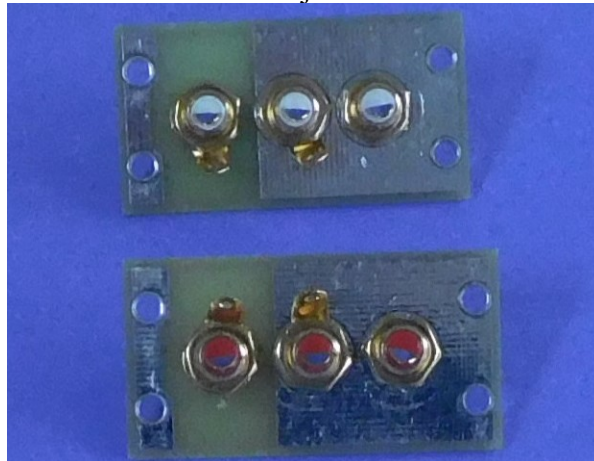

Figure 2-Installing the Jacks and ground lugs

The easiest way to install the jacks is to get the jacks and the ground lugs finger tight. Then tighten them well using two pairs of pliers. You don't want the jacks spinning on you after you've completed installation.

If your FM-5 has PC-25 and PC-26 circuit boards

The assembly procedure in this section covers FM-5's built with PC-25 and PC-26 circuit boards. Examine the copper side of both circuit boards to determine which FM-5 you have. Note that PC-25 and PC-26 represent later production vintages.

- The larger board, near the back of the chassis, will say PC-26.
- The smaller board, towards the front of the chassis, will say PC-25.

If your FM-5 has PC-20 and PC-21 circuit boards, then skip ahead to the section, "If your FM-5 has PC-20 and PC-21 circuit boards". If your FM-5 has PC-25 and PC-26 circuit boards, then continue in this section.

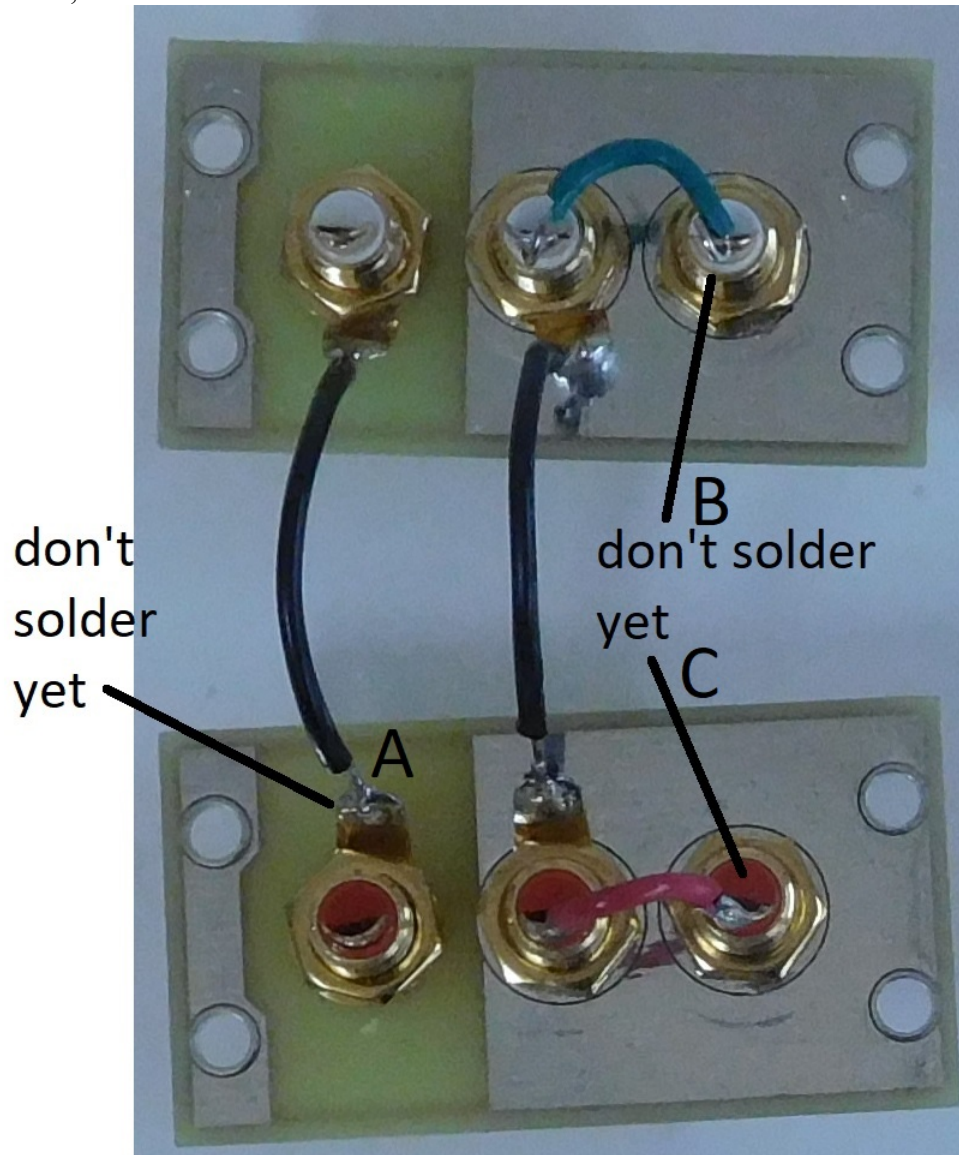

Figure 3-Pre-wire the jacks as shown, but don't yet solder the three indicated places

Add the ground wires to the jack assemblies:

1. Cut a two 2" lengths of black wire. Strip ¼" of insulation from all four ends. Form the bare ends into hooks. Slip those hooks into the ground lugs as shown in Figure 3.
2. Cut a 1" length of green wire, strip ¼" of insulation from both sides. Install the wires as shown in Figure 3. Solder and don't solder as indicated.
3. Cut a 1" length of red wire, strip ¼" of insulation from both sides. Install the wires as shown in Figure 3. Solder and don't solder as indicated.

Moving the wires from the old to the new jacks (PC-25 and PC-26).

Figure 4 shows the original RCA jack assembly wiring next to the partially wired new jacks. You'll move the wires from the old RCA jacks to the new ones.

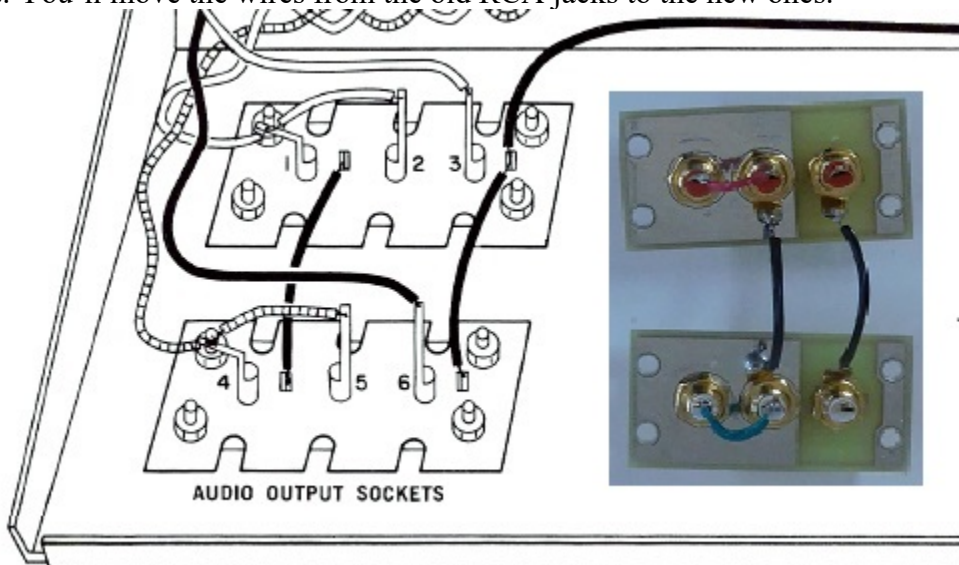

Figure 4-Set the new and old jacks side-by-side

Note the following:

- Jacks 3 and 6 have grounds that are isolated from the chassis.
- Jacks 1, 2, 4, and 5 have grounds that are connected to the chassis.
- When you install the new jacks, the isolated ground jacks will be located toward the center of the back panel.
- Make sure that the white insulator jacks align with the LEFT channel markings.
- Make sure that the red insulator jacks align with the RIGHT channel markings.
- Check Figure 7 to make sure that you know where and how the jacks will be installed.

Move the wires one at a time (PC-25 and PC-26)

Set the new and old jack assemblies as shown in Figure 4. Move the wires, one at a time, from the old jacks to the new jacks.

1. Black ground wire from RCA jack 3 ground. Add it to the ground strap and solder both wires.
2. Wire from RCA jack 3 center terminal to the center terminal of the new jacks (RED).

3. Wire from RCA jack 6 center terminal to center terminal of new jacks (WHITE).
Solder both wires.
4. Wire from RCA jack 1 center terminal to center terminal of new jack (RED).
Solder both wires.
5. Wire from RCA jack 4 center terminal to center terminal of new jack (WHITE).
Solder both wires.

Skip ahead to the section “Install the New Jacks and Reassemble the Tuner”.

If your FM-5 has PC-20 and PC-21 circuit boards

The assembly procedure in this section covers FM-5’s built with PC-20 and PC-21 circuit boards. Examine the copper side of both circuit boards to determine which FM-5 you have. Note that PC-20 and PC-21 represent the earliest vintage of the FM-5.

- The larger board, near the back of the chassis, will say PC-21.
- The smaller board, towards the front of the chassis, will say PC-20.

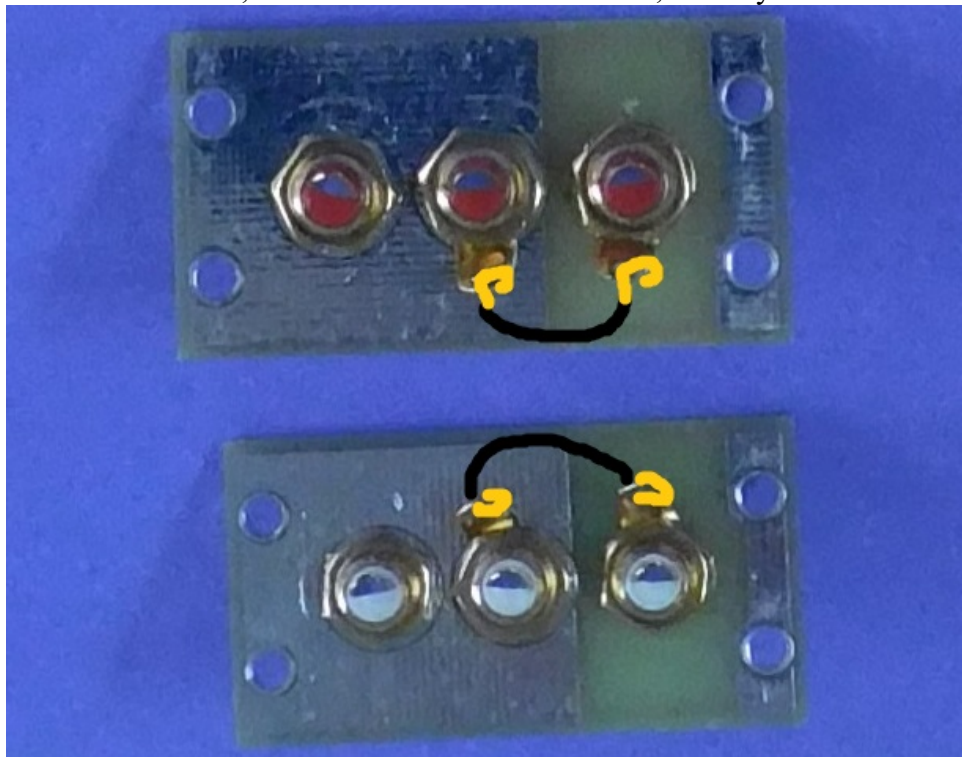

Figure 5-ground straps for PC-20 and PC-21 version of FM-5

Add the ground wires to the jack assemblies:

1. Cut a two 1.25” lengths of black wire. Strip ¼” of insulation from all four ends. Form the bare ends into hooks. Slip those hooks into the ground lugs as shown in Figure 5-ground straps for PC-20 and PC-21 version of FM-5.
2. Solder the wire on all four ground terminals. Note that you will have extra wire left over. That wire would be used if you had the PC-25/PC-26 version, but is not needed for the PC-20/PC-21 version of the FM-5.

Moving the wires from the old to the new jacks (PC-20 and PC-21).

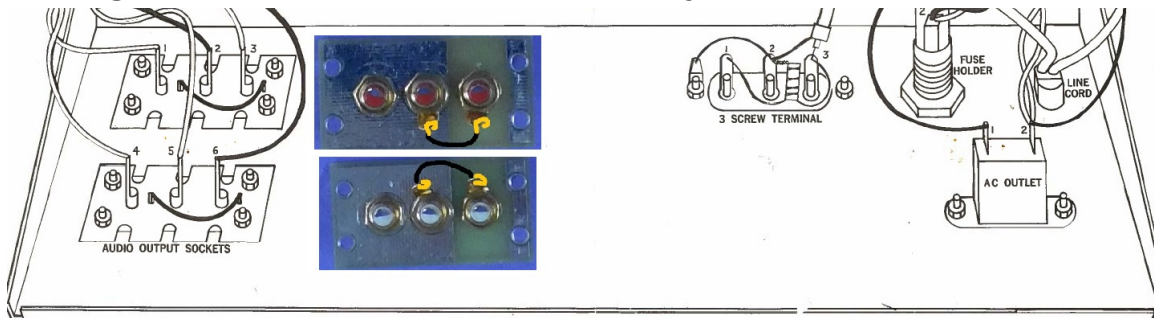

Figure 6 Figure 4 shows the original RCA jack assembly wiring next to the partially wired new jacks. You'll move the wires from the old RCA jacks to the new ones.

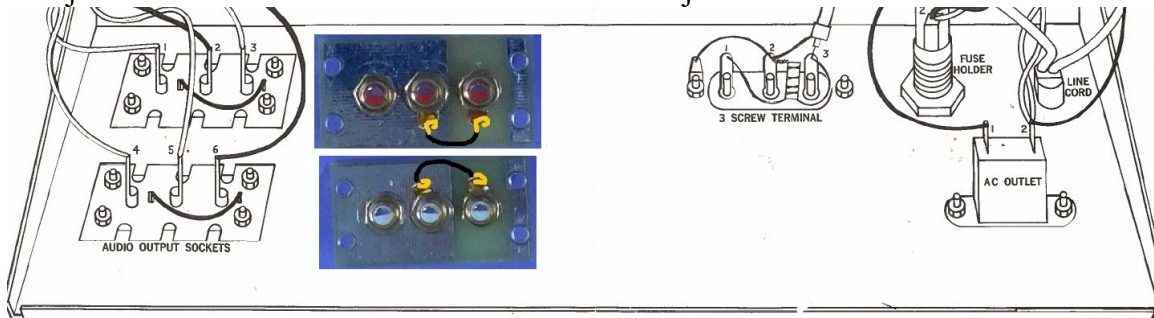

Figure 6-Set the new and old jacks side-by-side (PC-20 and PC-21 version)

Note the following:

- When you install the new jacks, the RCA jacks with no copper underneath it will be located toward the center of the back panel.
- Make sure that the white insulator jacks align with the LEFT channel markings.
- Make sure that the red insulator jacks align with the RIGHT channel markings.

Set the new and old jack assemblies as shown in Figure 6. Move the six wires, one at a time, from the center terminal of the old jacks to the center terminal of the new jacks.

Install the New Jacks and Reassemble the Tuner

The directions from this point forward are common to both versions of the FM-5.

Remove the hardware (8 4-40 screws and nuts) from the original RCA jacks. Don't re-use that hardware. Make sure to pick up all the lock-washers so they can't fall against the circuit board and cause annoying short circuits.

Install the new RCA jacks using the 8 supplied 4-40x5/16" screws and keps nuts. You'll notice that the keps nuts have built-in lockwashers. This makes for much easier re-assembly.

1. Line up the rear panel and re-install the 4 screws that hold it in place. Make sure that the points of the screws are kept away from the wires inside the FM-5.
2. Replace the cover on the chassis. Make sure the cover and chassis holes on the side match up.
3. Screw in the four screws that hold the cover to the chassis.



Figure 7-New jacks installed