

***BLUE LIGHT FOR  
DYNACO STEREO 120, SCA-80,  
OR PAT-4 ROCKER SWITCHES***



© 2014-2021 Akitika, LLC  
All rights reserved  
Revision 1p8 – August 3, 2021

## Table of Contents

Table of Contents .....	2
Table of Figures .....	2
Section 1: About This Manual .....	3
Who Should Attempt this Project? .....	3
Tools You'll Need.....	3
Project Overview .....	4
A Simple Way to View the Replacement .....	4
Important Safety Notes .....	4
Section 2: Building the Blue Light Assembly .....	5
Section 3: Installing Blue Light in a Stereo 120 .....	8
Opening the Amplifier .....	8
Removing the Power Switch.....	8
Section 4: Installing Blue Light in a PAT-4 PREAMP .....	13
Disassembling the PAT-4 Preamp .....	13
Installing the Blue Light Kit .....	13
Section 5: Schematic.....	15
Section 6: 240 Volt Compatibility .....	16

## Table of Figures

Figure 1-Blue LED PCB comes with 8 Blue LEDs pre-installed.....	5
Figure 2-Resistors prepared with insulation .....	5
Figure 3-Place 90-degree bend in one lead of each resistor .....	6
Figure 4-Insert and form the leads.....	6
Figure 5-back view of circuit board.....	6
Figure 6-solder the resistors. Be careful not to bridge the pads or to heat the LEDs .....	6
Figure 7-clip the extra bit of the resistor leads .....	7
Figure 8-cut the heat shrink tubing .....	7
Figure 9-Shrink the tubing by rubbing the tip of the iron along the tubing on all sides.....	7
Figure 10-completed assembly .....	8
Figure 11-Location of the four screws that hold the cover to the base.....	8
Figure 12-Remove the screws that hold the power switch in place.....	9
Figure 13-de-solder wire from the fuse holder to allow switch to come out.....	9
Figure 14-Make the 2 indicated cuts on the switch .....	10
Figure 15-switch after the wire cuts.....	10
Figure 16-Insert Blue Light assembly into the top of the switch.....	11
Figure 17-connect resistor leads to pins 1 and 2 of the power switch .....	11
Figure 18-Final assembly of blue light in switch.....	12
Figure 19-completed result .....	12
Figure 20-Cut two wires to allow the NE-2 lamp to be removed.....	13
Figure 21-install blue light assembly into the bottom of the switch and connect the resistors as shown .....	14
Figure 22-Schematic of Blue Light PCB and dropping resistors .....	15

## **Section 1: About This Manual**

This manual gives the information you need to build and install Blue Light to replace the orange NE-2 lamp in stock versions of Dynaco's Stereo 120 and PAT-4 power switches.

The Blue Light is an assembly of 8 small LEDs on a small circuit board that fits into the space of an NE-2 lamp. When you build the kit, you add dropping resistors, insulation, and heat shrink tubing (all included) to make the Blue Light assembly.

This manual also includes directions for removing the original NE-2, and replacing it with the Blue Light assembly.

### ***Who Should Attempt this Project?***

You can build this kit if you can:

1. solder (using normal rosin core solder and a soldering iron).
2. use simple hand tools like screwdrivers, wire cutters, and pliers.
3. read and follow directions.

It helps if you:

1. know a bit about electronics, or
2. have a friend who knows a bit about electronics
3. can get to YouTube to watch a few helpful videos about the assembly process (not available as of this version of the manual)

### ***Tools You'll Need***

You'll need the following tools to update your Stereo 120's power supply:

1. flat blade screwdriver for #6 screws
2. needle nose pliers (helpful, but not strictly necessary)
3. pencil type soldering iron of 25 to 50 Watts (no huge honking soldering guns or blowtorches)
4. wire cutters and strippers
5. Magnifying glass, if you're over 42!

## ***Project Overview***

The project consists of the following steps:

1. Building the Blue Light assembly.
2. Removing the power switch and the original NE-2 lamp.
3. Installing the Blue Light and connecting its power wires.
4. Reinstalling the power switch.

NOTE:

- Section 3 applies to installation in a Stereo 120.
- Section 4 applies to installation in a PAT-4.

Use the appropriate section for the job at hand.

## ***A Simple Way to View the Replacement***

The original orange neon lamp plus dropping resistor was compatible with 120 VAC. The new blue light PCB plus dropping resistors is also compatible with 120 VAC. Although we give you more details and guidance, you're basically just swapping the new (blue led PCB plus two resistors) for the old (orange neon lamp plus 1 dropping resistor).

## ***Important Safety Notes***

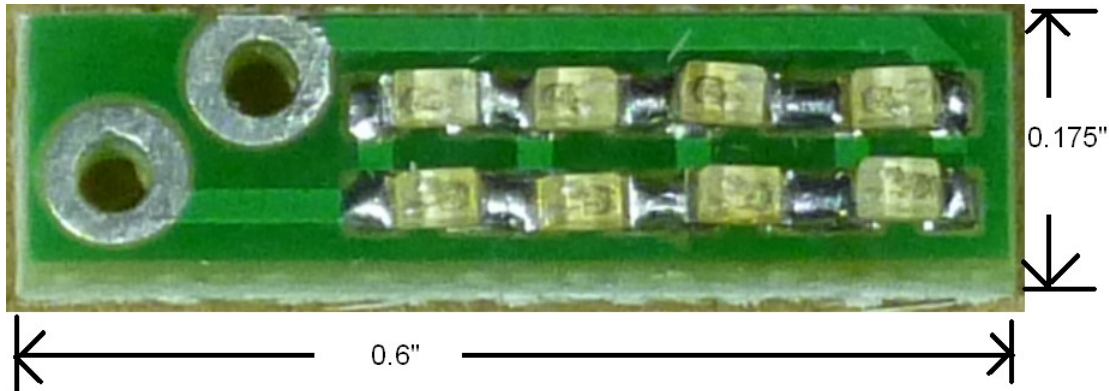
By purchasing, using, or assembling this kit, you have agreed to hold Akitika, LLC harmless for any injuries you may receive in its assembly and/or use. To prevent injuries:

- Wear safety glasses when soldering to prevent eye injuries.
- Always unplug the power before working on the amplifier.
- Large capacitors hold lots of energy for a long time. Before you put your hands into the amplifier:
  - Pull the AC plug!
  - Wait 1 full minute for the capacitors to discharge!
- Remove jewelry and rings from your hands and wrists, or anything that might dangle into the amplifier.
- If working in the amplifier, keep one hand in your pocket, especially if you're near the power supply or power supply wires. This can prevent serious shocks.
- Build with a buddy nearby. If you've ignored all the previous advice, they can dial 911 or get you to the hospital.

## Section 2: Building the Blue Light Assembly

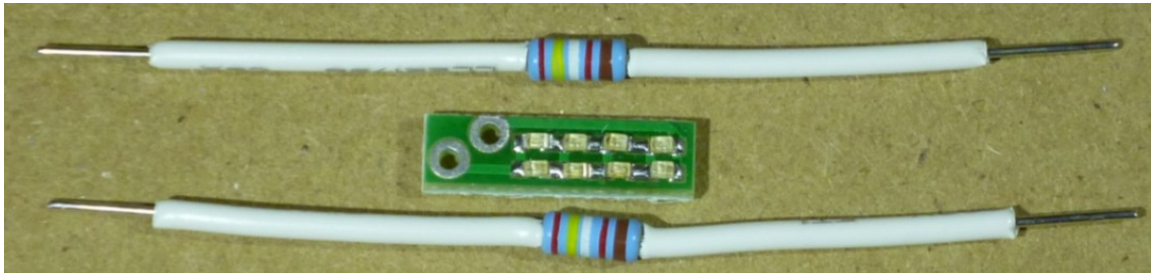
This section details the process of building the Blue Light assembly.

The Blue Light circuit board contains 8 LEDs, as shown in Figure 1. On the left side are two connection points into which dropping resistors will be placed after insulation is fitted over the resistor leads.



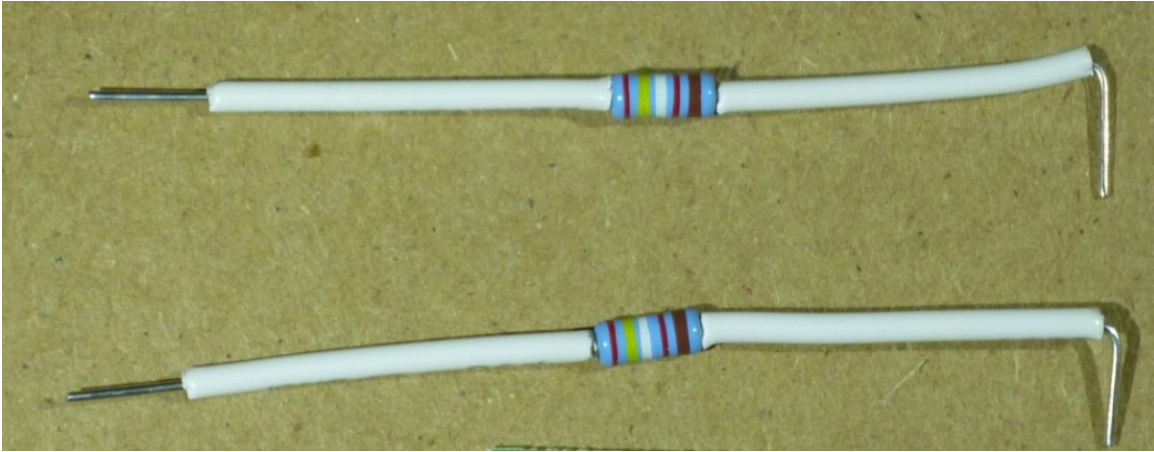
**Figure 1-Blue LED PCB comes with 8 Blue LEDs pre-installed**

1. Do not cut the resistor leads. Leave them full length.
2. Strip the supplied 22 AWG white wire to remove 4 pieces of insulation. The insulation is what we want. Each piece should be a bit more than 1" long.
3. Carefully measure and cut each piece of insulation down to 7/8" in length.
4. Slide the insulation over the resistor leads. The fit is snug, and the best way to get the insulation on the resistors is to spin it on using your thumb and index finger. This leaves a bit less than 1/4" of each lead bare.



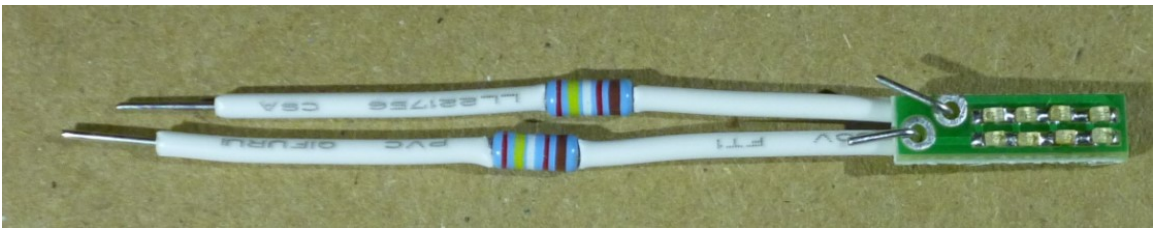
**Figure 2-Resistors prepared with insulation**

5. Put a 90 degree bend in both resistors, with the bend right up against the insulation, as shown in Figure 3.

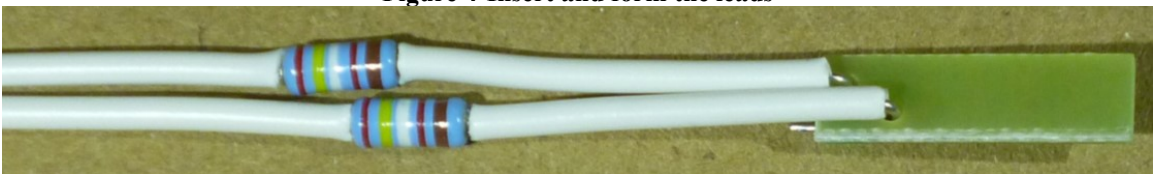


**Figure 3-Place 90-degree bend in one lead of each resistor**

6. Insert the resistor in the Blue Light PCB from the side *without* the LEDs. Form the leads as shown in Figure 4. Note that:
  - The lead from the lower resistor folds back directly over the incoming lead.
  - The lead from the lower resistor should point about 30 degrees above horizontal.

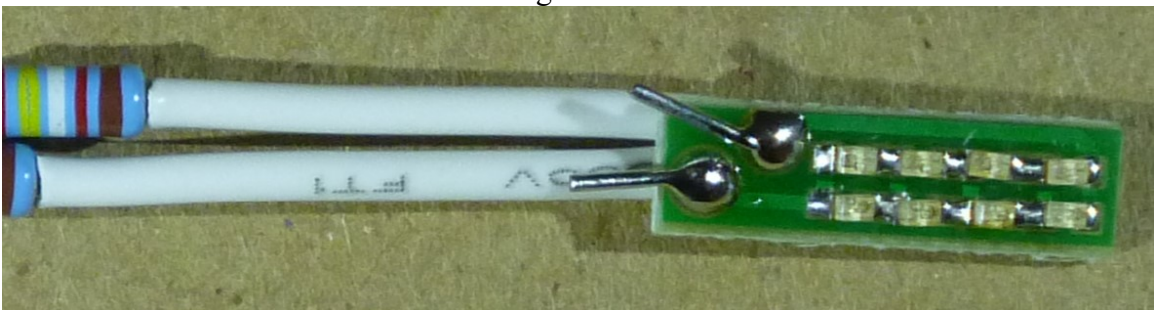


**Figure 4-Insert and form the leads**



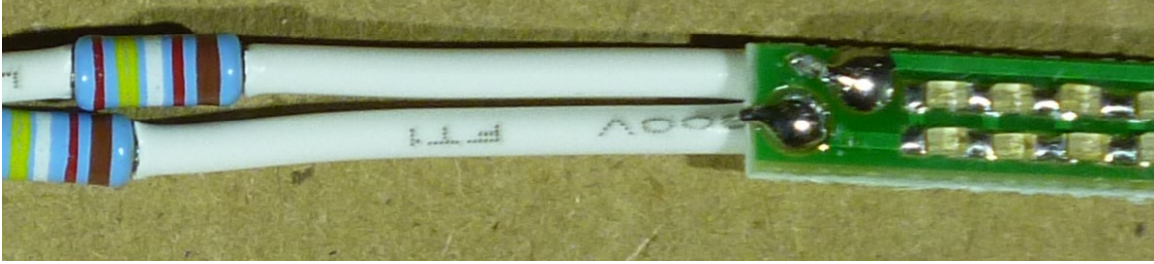
**Figure 5-back view of circuit board**

7. Solder the resistors as shown in Figure 6.



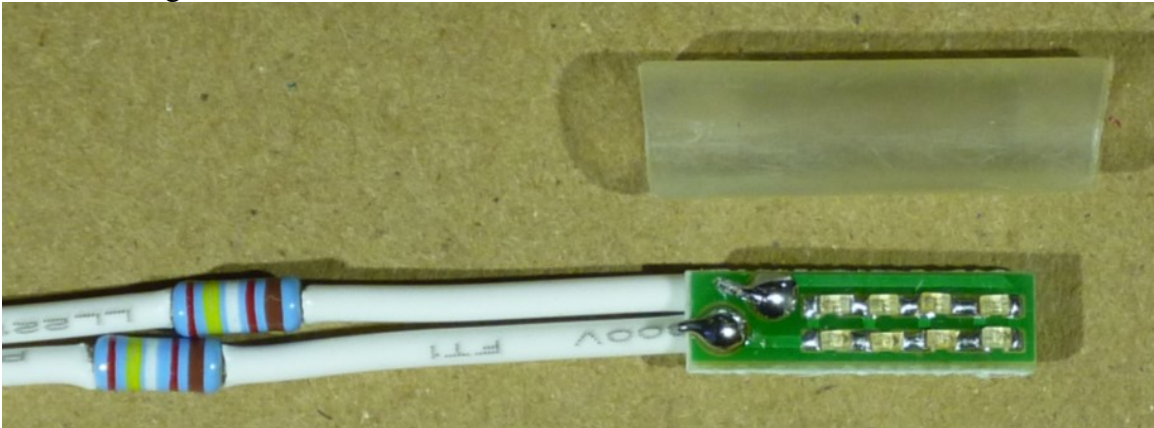
**Figure 6-solder the resistors. Be careful not to bridge the pads or to heat the LEDs**

8. Clip the extra lead as close as possible to the solder joints as shown in Figure 7. The result should be a smooth assembly, with no pointy wires protruding radially outward.



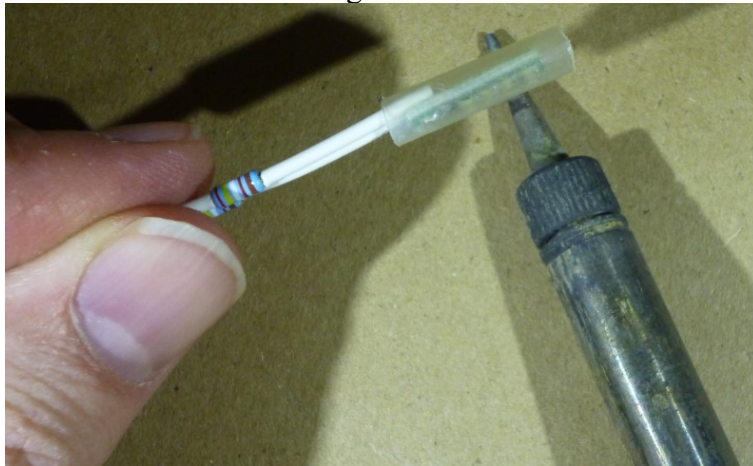
**Figure 7-clip the extra bit of the resistor leads**

9. Cut the supplied heat shrink tubing down to 7/8" in length. You can gauge the length by holding it next to the Blue Light PCB assembly. The heat shrink is a critical item. It insulates the high voltage from the power line that is applied through the 24K9 resistors.



**Figure 8-cut the heat shrink tubing**

10. Slide the heat shrink tubing over the PCB assembly and resistor connections. The object is for the heat-shrink to completely envelop the PCB and its resistor connections, preventing access to high voltage.
11. Run the tip of the soldering iron all around the heat shrink tubing. This will cause it to conform to the PCB, protecting the assembly, and making all the connections inaccessible. Don't linger too long in any one place and the shrinkage will be uniform from all directions. See Figure 9.



**Figure 9-Shrink the tubing by rubbing the tip of the iron along the tubing on all sides**

12. Figure 10 shows a close up of the completed assembly. Shrinking the heat-shrink tubing has locked the insulation in place.

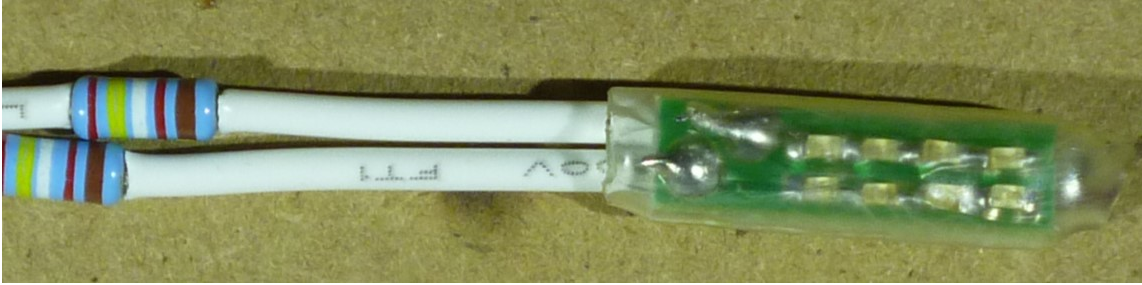


Figure 10-completed assembly

## Section 3: Installing Blue Light in a Stereo 120

*Make sure that the power cord is out, and has been out for at least 1 minute before starting this section.*

### Opening the Amplifier

1. *If you are installing the blue light assembly in a PAT-4, then skip to Section 4.*
2. *Make sure the amplifier is unplugged. If it was recently powered, allow the amp to sit for one full minute before proceeding.*
3. Remove the four screws along the outside edge of the bottom that hold the cover in place (see Figure 11).

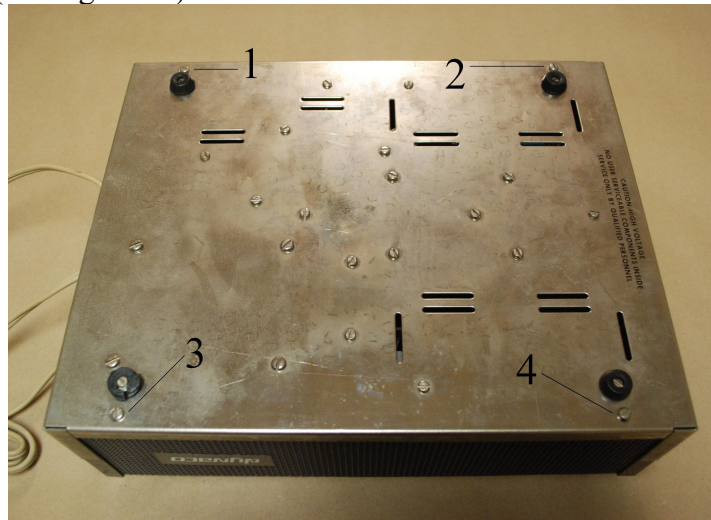


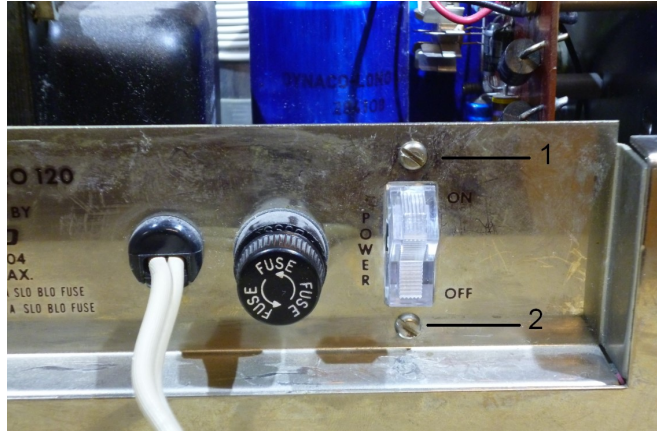
Figure 11-Location of the four screws that hold the cover to the base

4. Holding both the top and bottom of the amplifier, flip it over.
5. Lift the perforated metal top off of the amplifier.

### Removing the Power Switch

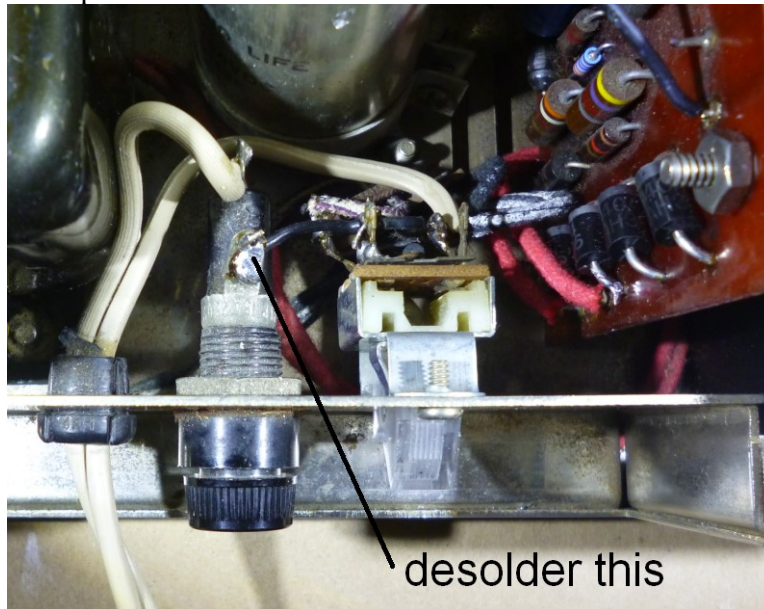
1. Remove the screws the hold the power switch in place. These are numbered 1 and 2 in Figure 12.





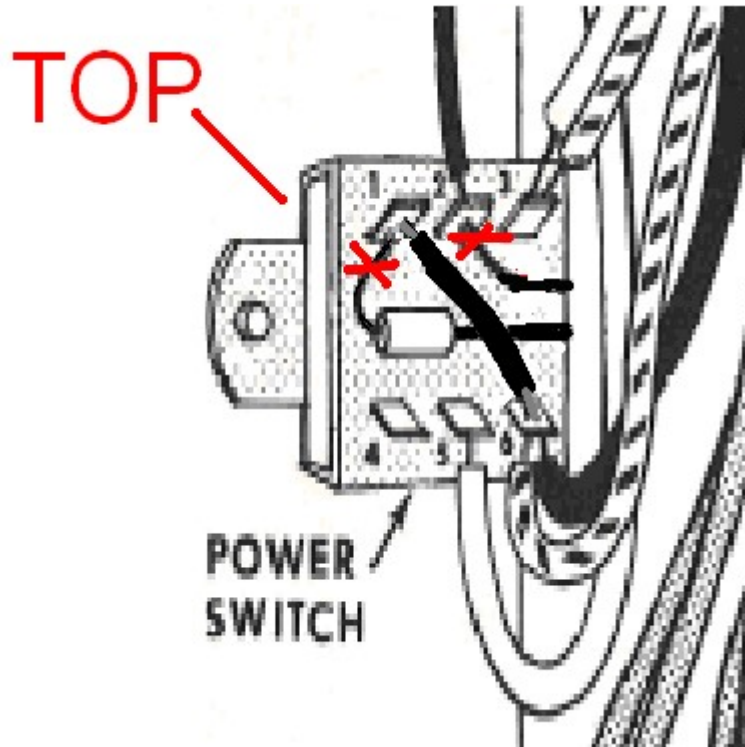
**Figure 12-Remove the screws that hold the power switch in place**

2. Identify the (usually) black wire that runs from the center terminal of the switch to the terminal of the fuse nearest the back panel, see Figure 13. Desolder it from the fuse side. This should give you enough freedom to carefully wiggle the switch out of the amplifier.



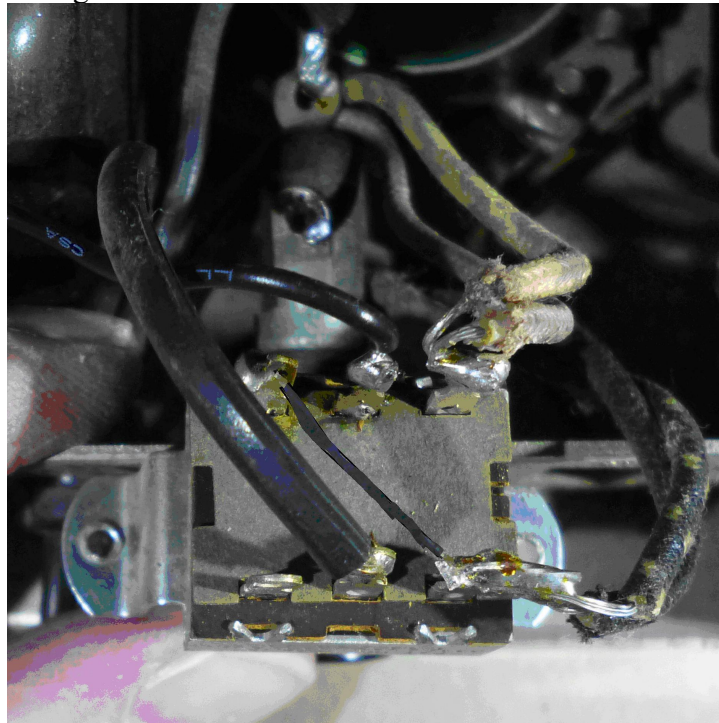
**Figure 13-de-solder wire from the fuse holder to allow switch to come out**

3. Cut the indicated wires on the switch as shown in Figure 14. These cuts will allow you to remove the old NE-2 orange lamp and dropping resistor.



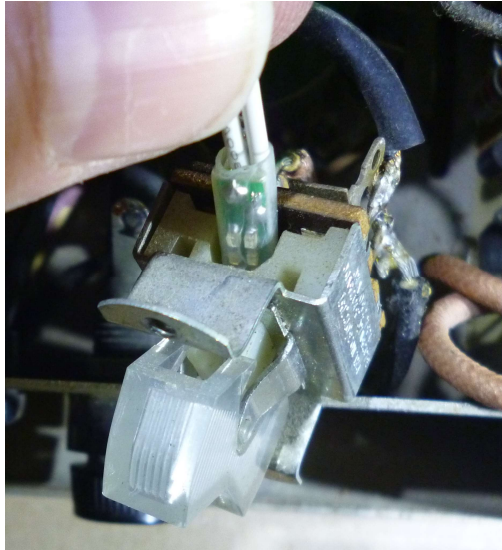
**Figure 14-Make the 2 indicated cuts on the switch**

4. Once the cuts are made, you can remove the neon lamp by sliding it out of the bottom of the switch. When you've completed this step, the switch will look like as shown in Figure 15. Make sure that the cardboard insulator remains in place.



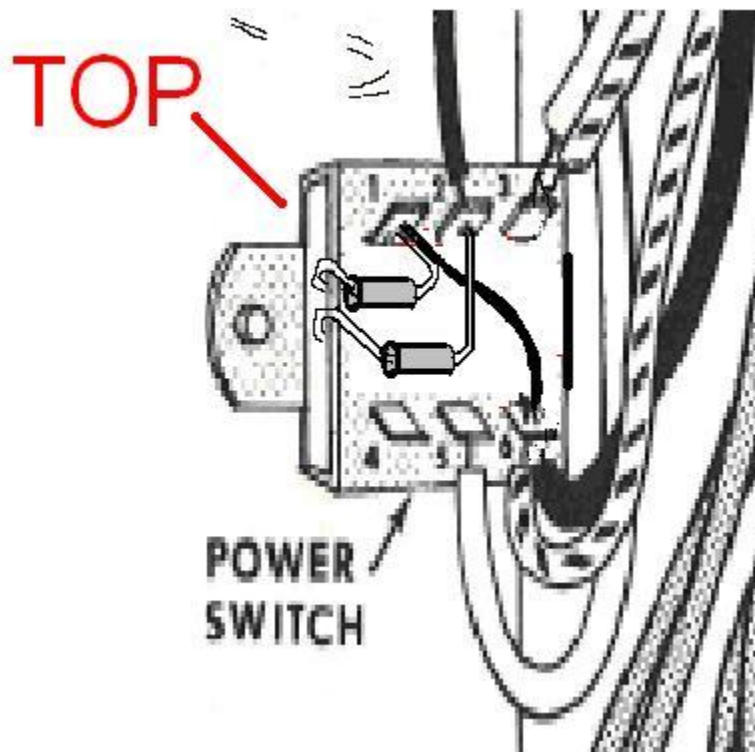
**Figure 15-switch after the wire cuts**

- Slide the Blue Light assembly with dropping resistors into the top of the switch, as shown in Figure 16. Make sure that the LED's face toward the rocker so that the blue light will be visible.



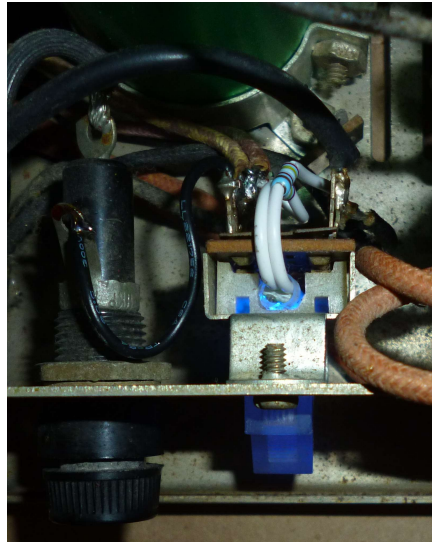
**Figure 16-Insert Blue Light assembly into the top of the switch**

- Form the resistors down and behind the switch. Remember that every resistor lead is covered with insulation. Bend a hook in the free end of both resistors. Connect the hooks as shown in Figure 17.



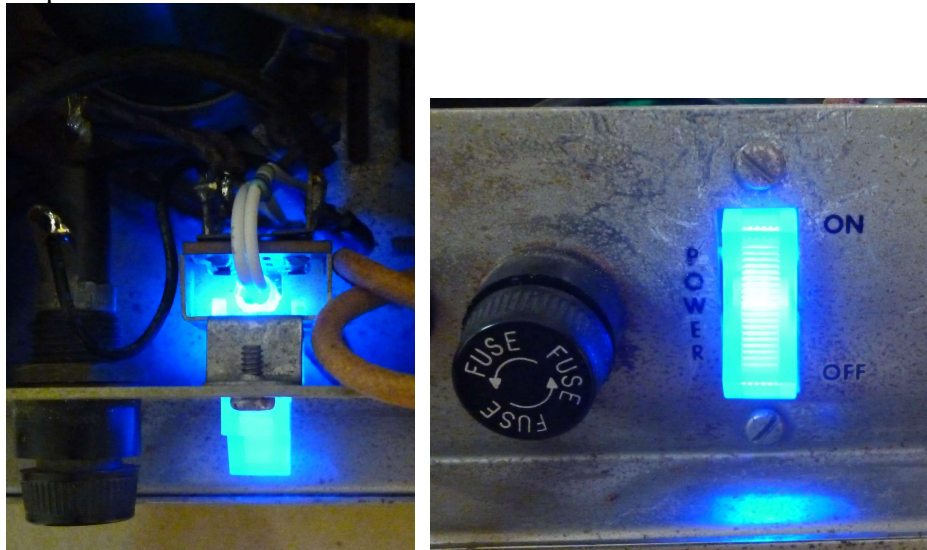
**Figure 17-connect resistor leads to pins 1 and 2 of the power switch**

7. Reconnect the wire previously de-soldered from the fuse in Step 2. Inspect your work to assure that there are no short circuits caused by solder blobs or other inadvertent actions.



**Figure 18-Final assembly of blue light in switch**

8. Put the switch back in position in the chassis and re-install the two retaining screws. You may find that you have to adjust the switch up and down so that both edges of the rocker switch clear the mounting hole.
9. Place the rocker switch in the OFF position. Standing well clear of the amplifier, plug it in to the AC outlet. Keeping your hands outside the chassis, move the rocker switch to the ON position. The Blue Light should turn on.
10. Re-install the cover and the retaining screws. Figure 19 gives two views of the completed result.



**Figure 19-completed result**

## Section 4: Installing Blue Light in a PAT-4 PREAMP

*Make sure that the power cord is out, and has been out for at least 1 minute before starting this section.*

### Disassembling the PAT-4 Preamp

Here are the steps to disassemble the PAT-4 preamp to the extent you'll need to in order to gain access to the power switch:

1. Remove the 4 sheet metal screws (two on each side) that hold the cover of the chassis in place.
2. Lift the cover off the chassis.
3. Center all the rotary controls. This will make it easier to put the knobs back at the right orientation. They must be removed to remove the front panel.
4. Carefully loosen the set screws in all the knobs. Remove the knobs and set them in a safe place.
5. Remove the retaining nuts on the control shafts which hold the front panel to the sub-chassis.
6. Remove the front panel.
7. Remove the two slotted #4 screws that hold the power switch into the front of the sub-chassis.
8. Pull the power switch and its attached wires out the side of the PAT-4, so you'll have room to work on the switch.

### Installing the Blue Light Kit

1. Make the indicated cuts as shown in Figure 20.

Cut original neon lamp assembly as indicated to remove.

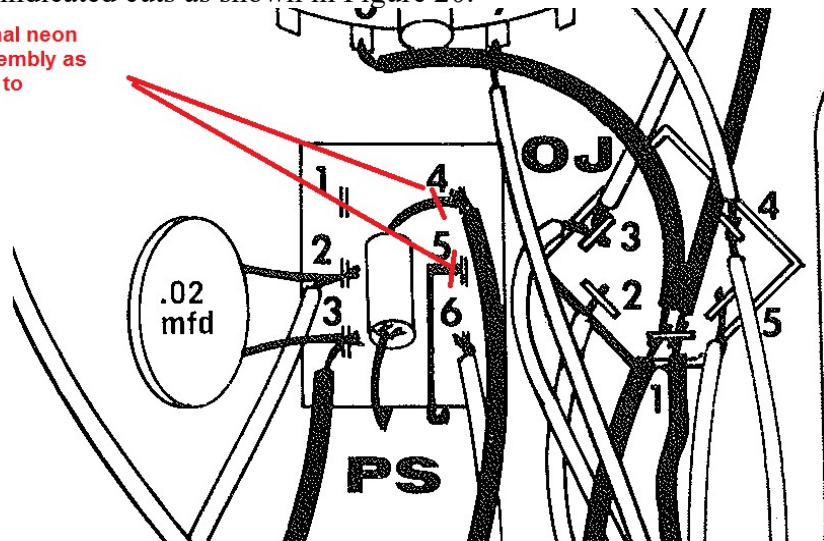


Figure 20-Cut two wires to allow the NE-2 lamp to be removed

2. Remove the old NE-2 lamp and dropping resistor, pulling them out of the bottom of the switch.
3. Slide the blue light assembly into the bottom of the switch, making sure that the LEDs face so they will shine into the clear portion of the rocker switch.

4. Connect the two resistors of the LED assembly to pins 4 and 5 of the power switch, as shown in Figure 21.

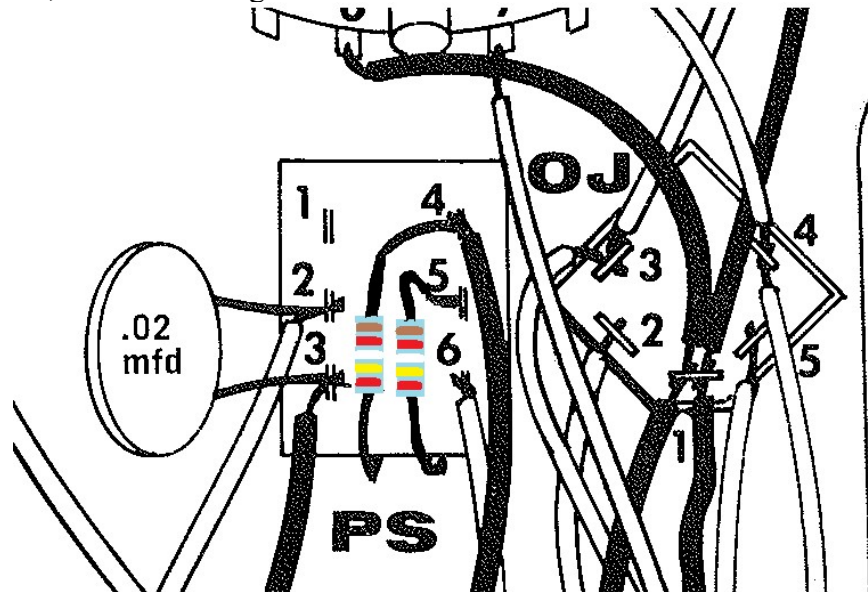


Figure 21-install blue light assembly into the bottom of the switch and connect the resistors as shown

5. Center the blue light assembly in the switch and make sure that the rocker operates without binding.
6. Form the insulated resistor leads (on the side away from the blue light board), connecting the ¼" uninsulated ends to pins 4 and 5 of the switch, as shown in Figure 21-install blue light assembly into the bottom of the switch and connect the resistors as shown in Figure 21.
7. Reinstall the rocker switch to the chassis, using the 2 #4 screws which originally held it in place.
8. Examine your work to make sure the wires are neither pinched nor shorting.

*If you're careful at this point, you can plug the PAT-4 in and operate the switch to test the operation and look of the blue light kit. Just be sure to keep your hands away from the high voltage inside the PAT-4.*

9. Remove the plug, and allow 1 minute to pass before touching the PAT-4 Premap.
10. Replace the front panel, and secure it in place with the same nuts on the controls which originally held it in place.
11. Replace the knobs, lining up their indicator lines on the center lines of the controls, matching how they were when they were removed.
12. Re-install the cover, and secure it in place with the 4 sheet metal screws.

## Section 5: Schematic

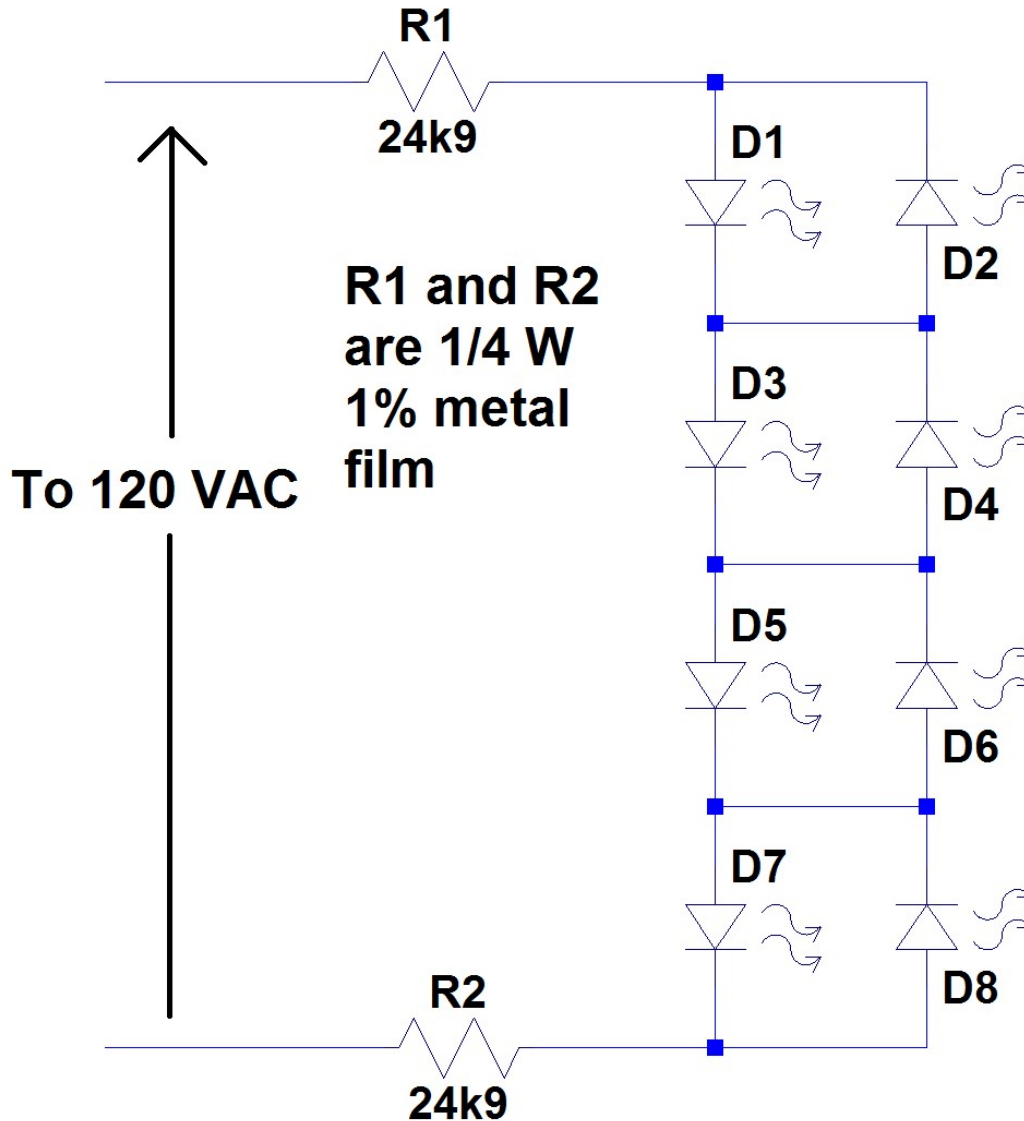


Figure 22-Schematic of Blue Light PCB and dropping resistors

The blue light board is powered by 110 Volts AC (alternating current). AC alternately applies positive and negative polarity voltage to the input of the circuit. When the polarity is positive on top and negative on the bottom, then D1, D3, D5, and D7 are forward biased, so they conduct current and produce light. When the polarity is negative on top and positive on the bottom, then D2, D4, D6, and D8 produce light.

The anti-parallel connection of the LEDs assures that none of the diodes sees an excessive reverse bias when its partner in the anti-parallel pair is conducting. The 24K9 resistors limit the current through the diodes to about 2 mA, which is well under the rated maximum current for the diodes.

## **Section 6: 240 Volt Compatibility**

The blue LED assembly with the 24K9 dropping resistors drops in any place that the original orange Neon lamp plus its single dropping resistor would have gone. Both assemblies are intended for use on 120 volts AC.

They may both be used in 240 Volt AC wired Stereo 120's and PAT-4's so long as the power wiring is done like the original manuals, and as shown in revisions of this manual with 2014 and later dates.

The “trick” that Dynaco accomplished with their somewhat unusual looking switch wiring was to use the windings of the power transformer as a voltage divider. Thus, even when wired for 240 Volts, only 120 volts appears across the blue light plus dropping resistors.

Note that earlier versions of the manual showed this arrangement for the PAT-4, but a different arrangement for the Stereo 120. That earlier arrangement for the Stereo 120 was not compatible with 240 volt wired units.